

# OUTLINE DIMENSIONAL DRAWING

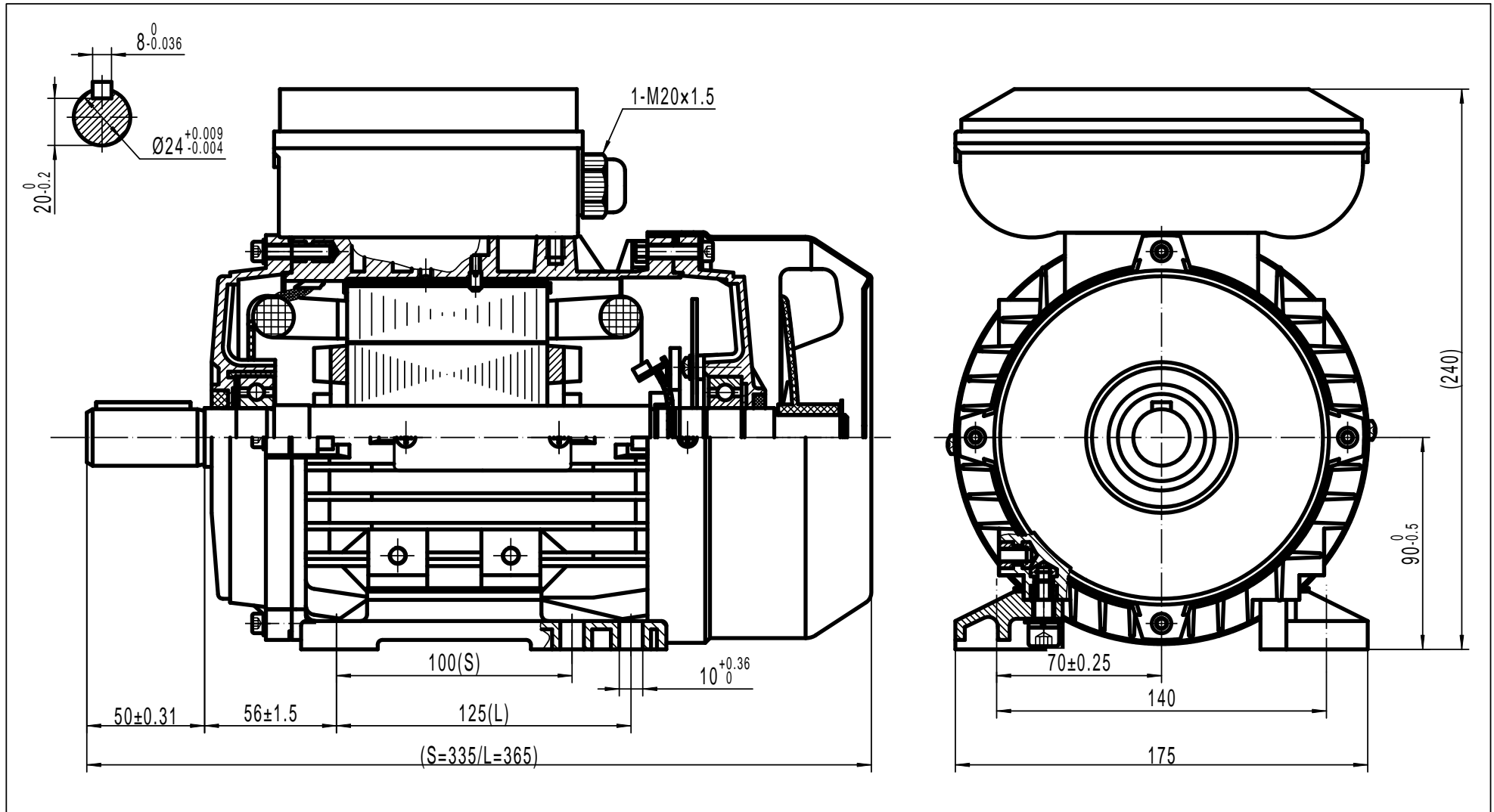

TECHTOP AUSTRALIA PTY LTD	
FRAME	TML 90A B3
DATE	DRAWING NO.
2008/05/20	1TB.390.046