

OUTLINE DIMENSIONAL DRAWING

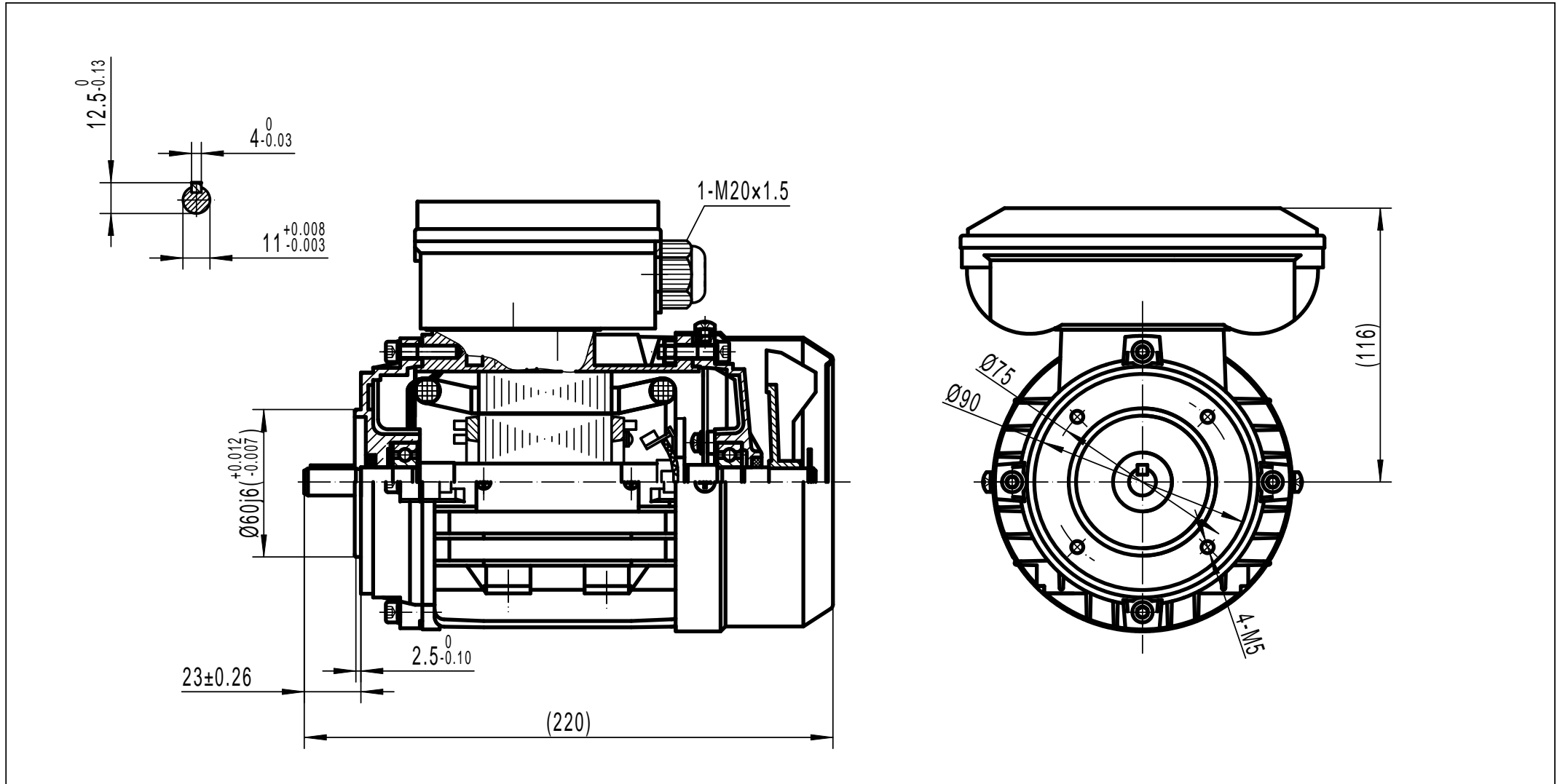

TECHTOP AUSTRALIA PTY LTD	
FRAME	TML 63A B14
DATE	DRAWING NO.
2008/05/20	1TB.390.033