

OUTLINE DIMENSIONAL DRAWING

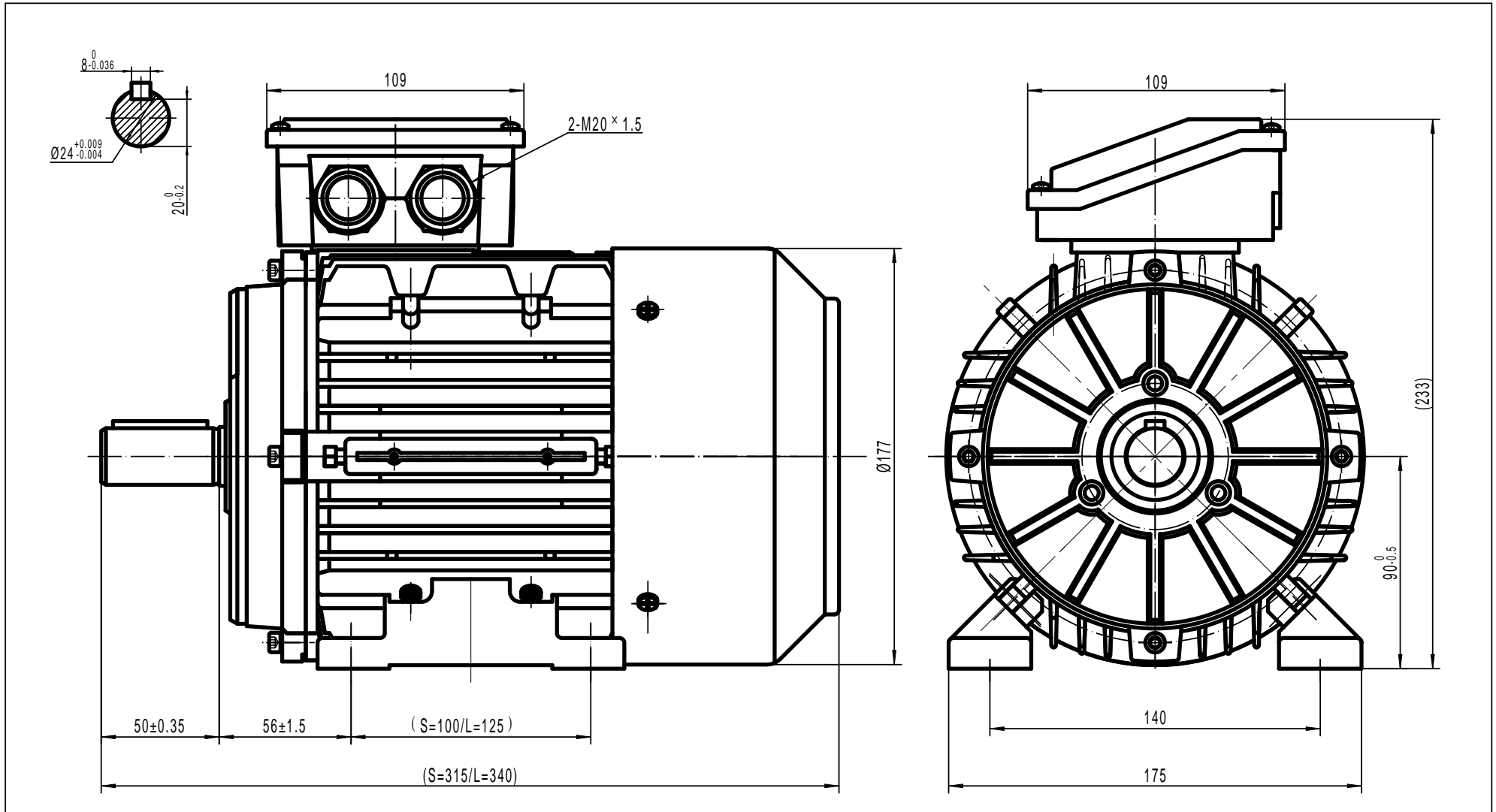

TECHTOP AUSTRALIA PTY LTD	
FRAME	TAI 90A B3
DATE	DRAWING NO.
2011/10/14	1ST084.050.001-021 A