

OUTLINE DIMENSIONAL DRAWING

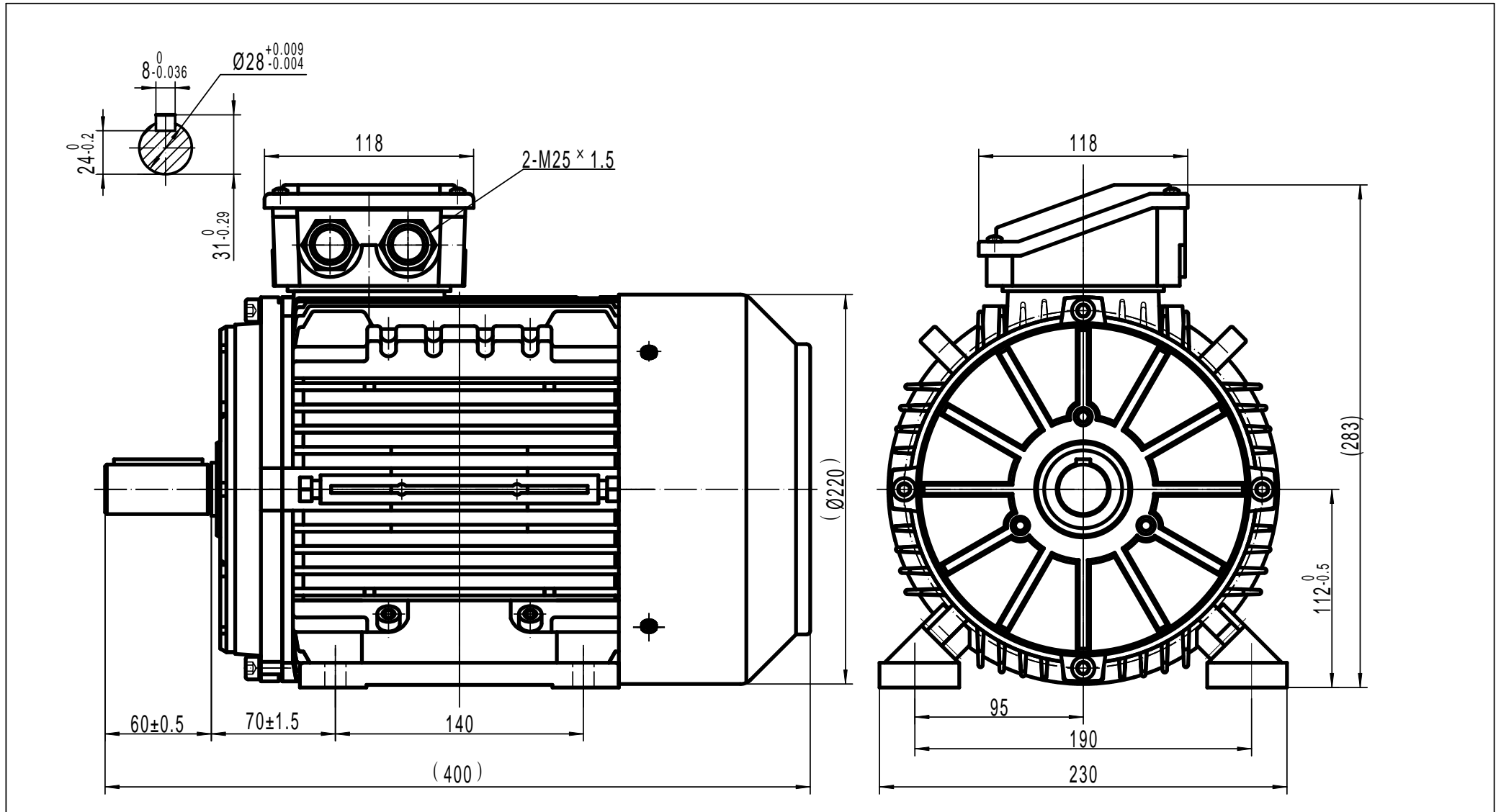

TECHTOP
A U S T R A L I A

TECHTOP AUSTRALIA PTY LTD	
FRAME	TAI 112A B3
DATE	DRAWING NO.
2011/10/14	1ST086.050.001-024 A