

OUTLINE DIMENSIONAL DRAWING

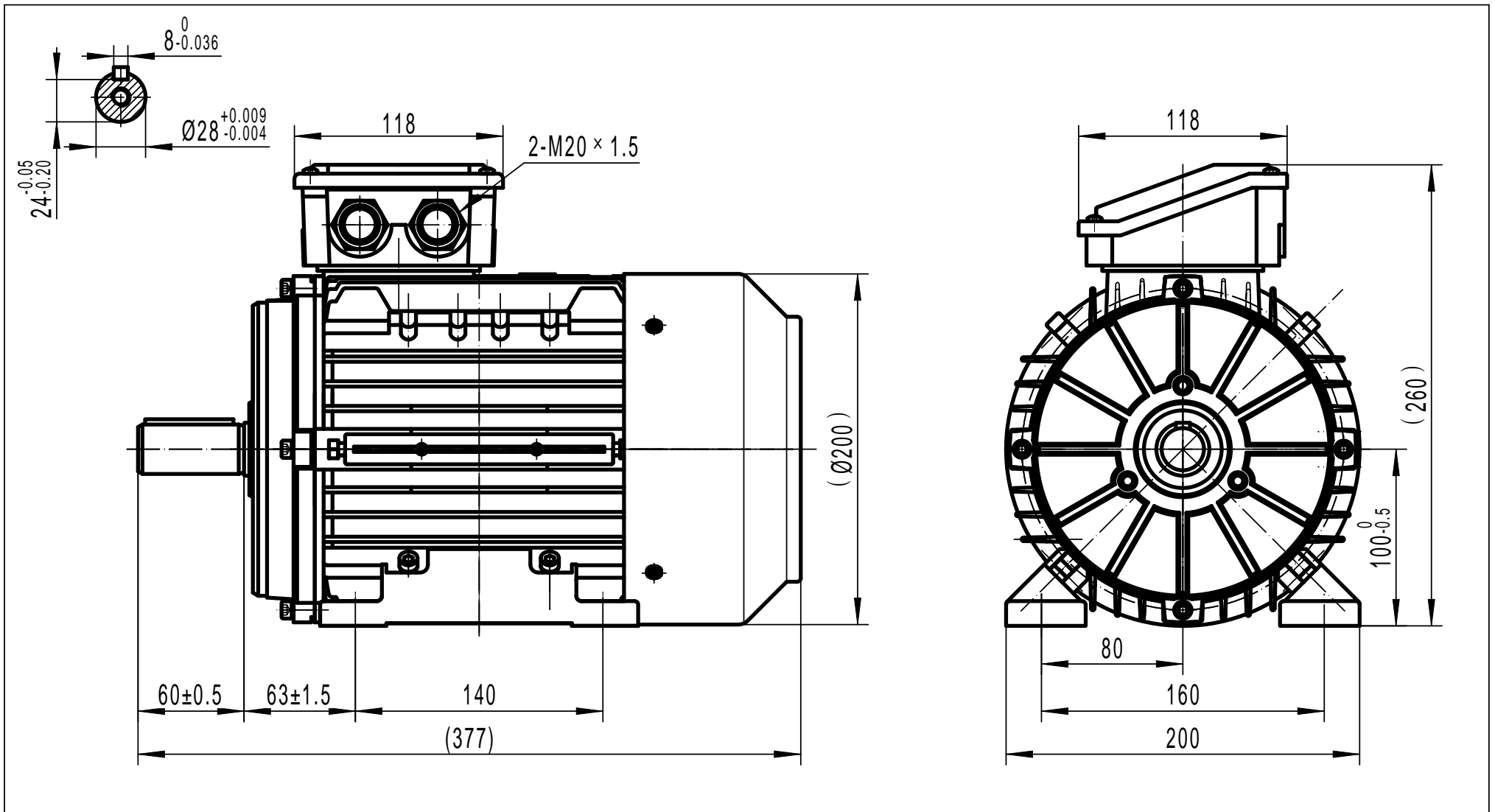

TECHTOP AUSTRALIA PTY LTD	
FRAME	TAI 100A B3
DATE	DRAWING NO.
2011/10/14	1ST085.050.001-021 A